

Parts List

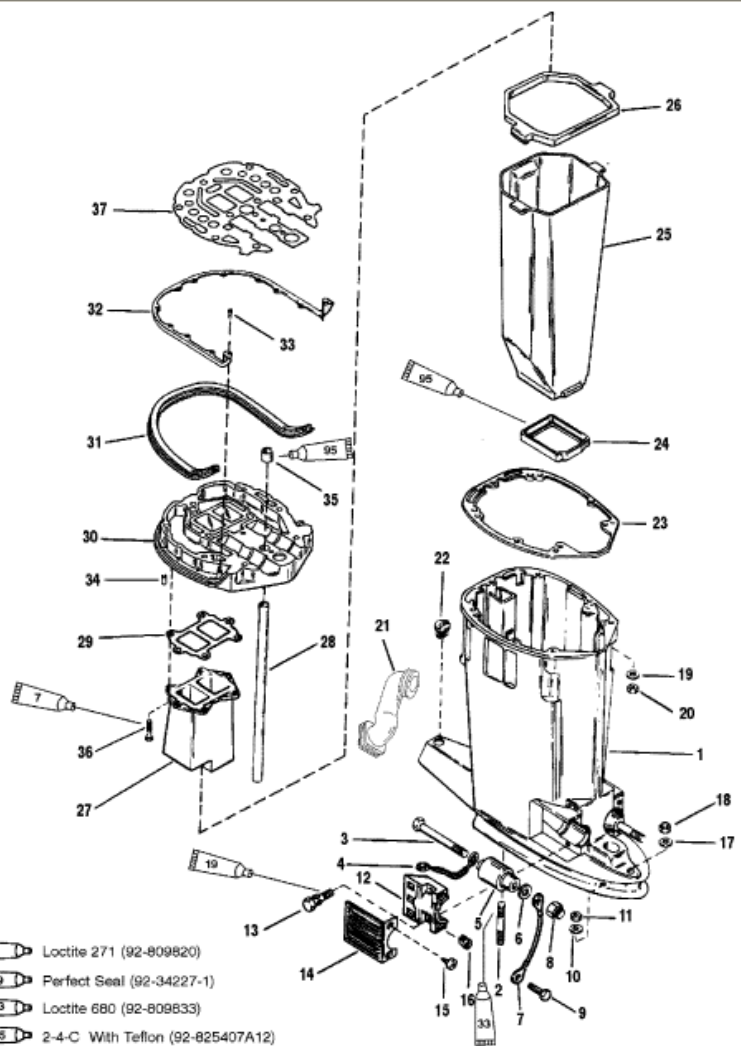

Ref	Class	Part	Description	Qty	Comment	Footnote
1	1590	8343T10	DRIVE SHAFT HOUSING	1	(BLACK-LONG)	
1	3503	813563T 1	DRIVE SHAFT HOUSING	1	(BLACK-X-LONG)	
1	1590	8343A13	DRIVE SHAFT HOUSING	1	(BLACK-JET)	
2	16	56295	STUD	2		
3	10	63474	SCREW (1/2-20 X 6)	2		
4		88238A10	GROUND WIRE	1		
5		78249	LOWER MOUNT	2	(135/175 LONG)(JET)	
5		77327	LOWER MOUNT	2	(ALL OTHER MODELS)	
6	12	49339	WASHER	2		
7		88238A10	GROUND WIRE	1		
8	11	28040	NUT	2		
9	10	41508	SCREW (1/4-20 X 3/8)	1		
10	12	45176	WASHER	2		
11	11	34933	NUT	2		
12	54	67076	CLAMP	2		
13	10	66727	SCREW (5/16-18 X 1-1/4 IN.)	4		
14		67077T	COVER	2	(BLACK)	
15	10	88417	SCREW (12-24 X 5/8 IN.)	4		
16	11	35521	NUT	4		
17	12	48926	WASHER	1		
18	11	34933	NUT	1		
19	12	20553	WASHER	4		
20	11	69254	NUT	4		
21		828212	IDLE EXHAUST BOOT	1		
22	19	64649	PLUG	1		
23	27	99173 2	GASKET	1		4
24		66350	SEAL (LOWER)	1		
25		18276	EXHAUST TUBE	1		
26		17726 1	SEAL (UPPER)	1		
27		812834	EXHAUST EXTENSION	1	(135/150/175-XR6/MAGNUM III)	
27		41942F 3	EXHAUST EXTENSION	1	(200) (JET)	
28	32	67295	WATER TUBE	1	(LONG) (JET)	
28	32	74729	WATER TUBE	1	(X-LONG)	
29	27	78246	GASKET	1		4
30		18233A 3	PLATE ASSEMBLY	1		
31		814701 2	SEAL	1		
32		68011	BRACKET	1		
33	10	812832	SCREW (10-16 X 1/2 IN.)	12		
34	17	43044	DOWEL PIN	2		
35	26	38970	SEAL	1		4
36	10	90192	SCREW (1/4-20 X 3/4)	6		